

# GP1A75E

## Small Size OPIC Photointerrupter with Connector

### ■ Features

1. 3-pin connector terminal
2. High sensing accuracy  
(Slit width: 0.5mm)
3. Wide gap between light emitter and detector (5mm)

### ■ Applications

1. Copiers
2. Laser beam printers
3. Facsimiles

### ■ Outline Dimensions

(Unit : mm)

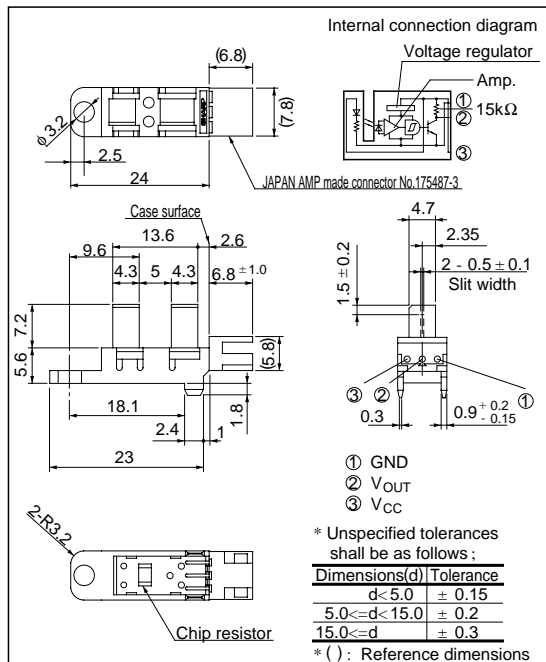

\*\*"OPIC" (Optical IC) is a trademark of the SHARP Corporation.

An OPIC consists of a light-detecting element and signal-processing circuit integrated onto a single chip.

### ■ Absolute Maximum Ratings (T<sub>a</sub>= 25°C)

Parameter	Symbol	Rating	Unit
Supply voltage	V <sub>CC</sub>	- 0.5 to + 10	V
*1 Low level output current	I <sub>OL</sub>	50	mA
*2 Operating temperature	T <sub>opr</sub>	- 20 to + 75	°C
*2 Storage temperature	T <sub>stg</sub>	- 30 to + 85	°C

\*1 Collector current of output transistor

\*2 The connector should be plugged in/out and the unit's hook should be used at normal temperature.

**■ Electro-optical Characteristics**

(Unless otherwise specified,  $V_{CC} = 5V, T_a = 25^\circ C$ )

Parameter		Symbol	Conditions	MIN.	TYP.	MAX.	Unit
Operating supply voltage		$V_{CC}$	-	4.5	-	5.5	V
Low level supply current		$I_{CCL}$	Light beam interrupted	-	-	20	mA
Low level output voltage		$V_{OL}$	Light beam interrupted, $I_{OL} = 16mA$	-	-	0.35	V
High level supply current		$I_{CCH}$	Light beam uninterrupted	-	-	20	mA
High level output voltage		$V_{OH}$	Light beam uninterrupted	$V_{CC} \times 0.9$	-	-	V
Response characteristics	Minimum interruption time	$t_H$	-	166	-	-	$\mu s$
	Minimum sensing time	$t_L$	-	166	-	-	$\mu s$

**Fig. 1 Low Level Output Current vs. Ambient Temperature**

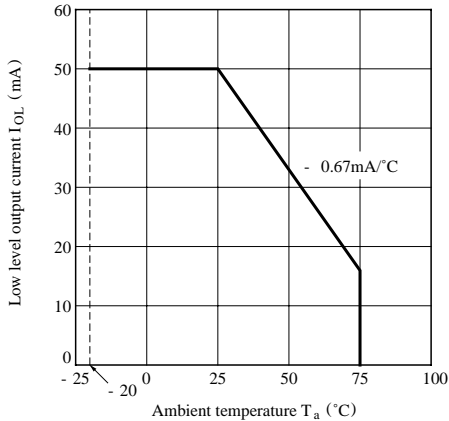

**Fig. 2 Low Level Output Voltage vs. Low Level Output Current**

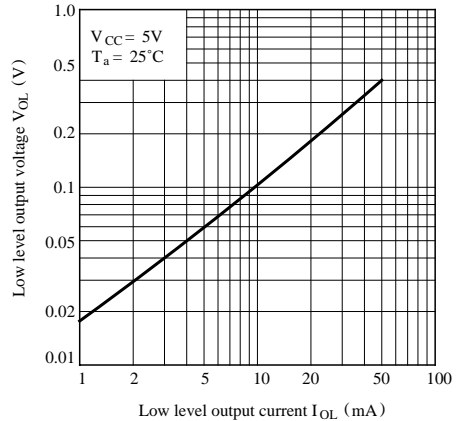

**Fig. 3 Low Level Output Voltage vs. Ambient Temperature**

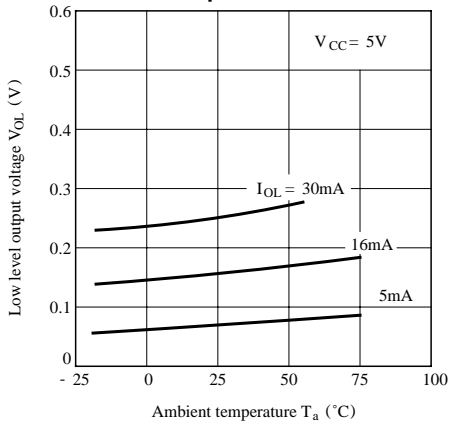

**Fig. 4 Supply Current vs. Supply Voltage**

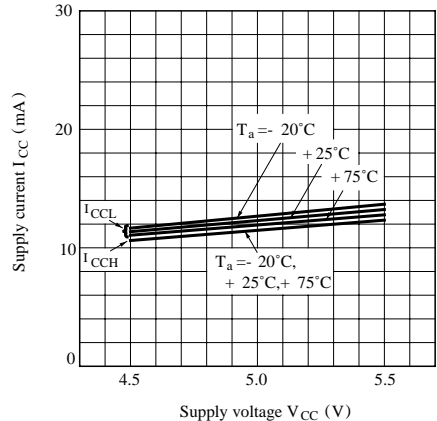

Fig. 5 Detecting Position Characteristics (1)

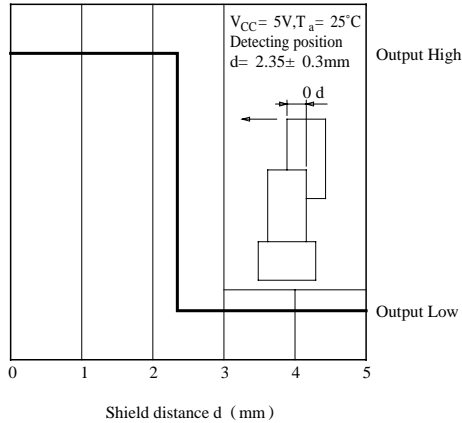
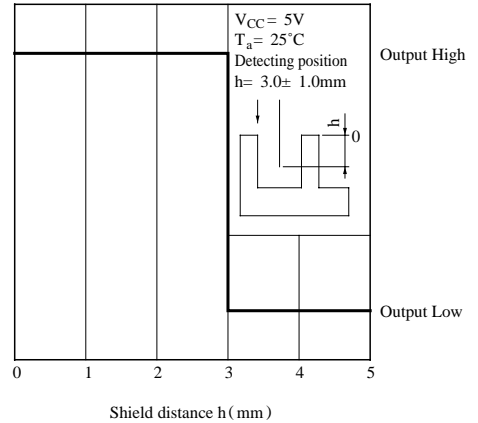
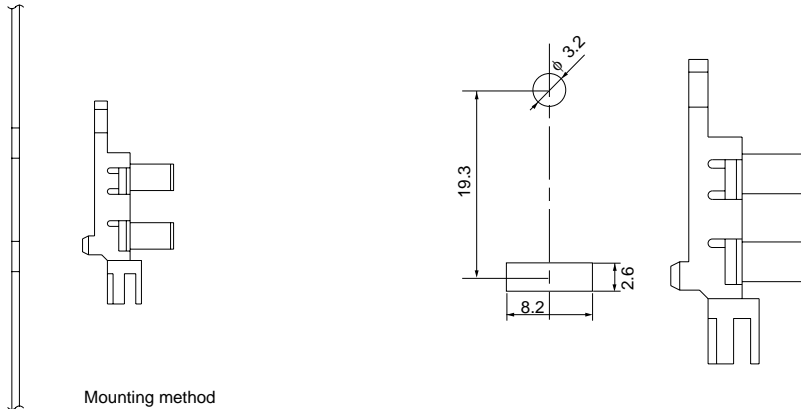

Fig. 6 Detecting Position Characteristics (2)



### ■ Recommended Mounting Holes (Unit : mm)



### ■ Precautions for Use

- (1) In this product, the PWB is fixed with a hook, and cleaning solvent may remain inside the case; therefore, dip cleaning or ultrasonic cleaning are prohibited.
- (2) Remove dust or stains, using an air blower or a soft cloth moistened in cleaning solvent. In this case, use only the following type of cleaning solvent used for wiping off:  
Ethyl alcohol, Methyl alcohol, Isopropyl alcohol  
When the cleaning solvents except for specified materials are used, please consult us.
- (3) In order to stabilize power supply line, connect a by-pass capacitor of more than  $0.01\mu F$  between  $V_{cc}$  and GND near the device.
- (4) As for other general cautions, refer to the chapter“Precautions for Use”.

### NOTICE

- The circuit application examples in this publication are provided to explain representative applications of SHARP devices and are not intended to guarantee any circuit design or license any intellectual property rights. SHARP takes no responsibility for any problems related to any intellectual property right of a third party resulting from the use of SHARP's devices.
- Contact SHARP in order to obtain the latest device specification sheets before using any SHARP device. SHARP reserves the right to make changes in the specifications, characteristics, data, materials, structure, and other contents described herein at any time without notice in order to improve design or reliability. Manufacturing locations are also subject to change without notice.
- Observe the following points when using any devices in this publication. SHARP takes no responsibility for damage caused by improper use of the devices which does not meet the conditions and absolute maximum ratings to be used specified in the relevant specification sheet nor meet the following conditions:
  - (i) The devices in this publication are designed for use in general electronic equipment designs such as:
    - Personal computers
    - Office automation equipment
    - Telecommunication equipment [terminal]
    - Test and measurement equipment
    - Industrial control
    - Audio visual equipment
    - Consumer electronics
  - (ii) Measures such as fail-safe function and redundant design should be taken to ensure reliability and safety when SHARP devices are used for or in connection with equipment that requires higher reliability such as:
    - Transportation control and safety equipment (i.e., aircraft, trains, automobiles, etc.)
    - Traffic signals
    - Gas leakage sensor breakers
    - Alarm equipment
    - Various safety devices, etc.
  - (iii) SHARP devices shall not be used for or in connection with equipment that requires an extremely high level of reliability and safety such as:
    - Space applications
    - Telecommunication equipment [trunk lines]
    - Nuclear power control equipment
    - Medical and other life support equipment (e.g., scuba).
- Contact a SHARP representative in advance when intending to use SHARP devices for any "specific" applications other than those recommended by SHARP or when it is unclear which category mentioned above controls the intended use.
- If the SHARP devices listed in this publication fall within the scope of strategic products described in the Foreign Exchange and Foreign Trade Control Law of Japan, it is necessary to obtain approval to export such SHARP devices.
- This publication is the proprietary product of SHARP and is copyrighted, with all rights reserved. Under the copyright laws, no part of this publication may be reproduced or transmitted in any form or by any means, electronic or mechanical, for any purpose, in whole or in part, without the express written permission of SHARP. Express written permission is also required before any use of this publication may be made by a third party.
- Contact and consult with a SHARP representative if there are any questions about the contents of this publication.